

A TAXONOMY OF SPACE-TIME PROCESSING FOR WIRELESS NETWORKS

*Arogyaswami J. Paulraj**

Erik Lindskog

Information Systems Laboratory

Signals and Systems

Stanford University

Uppsala University

Stanford, CA 94305-9510

PO Box 528, SE-751 20 Uppsala

USA

Sweden

ABSTRACT

A taxonomy of space-time signal processing is addressed in terms of architectural and algorithmic classification, and the influence of the propagation channel on the space-time processing. The architecture is classified according to link structure, channel reuse and multiple access scheme. Algorithms are classified into channel estimation methods, TDMA and CDMA receive algorithms and space-time transmit algorithms. Finally, the effects of Doppler spread, delay spread and angle spread on space-time processing is addressed.

*This research was supported by the Department of the Army Army Research Office, under Grant No. DAAH04-95-1-0249. The views and conclusions contained in this document are those of the authors and should not be interpreted as necessarily representing the official policies or endorsements, either expressed or implied, of the Army Research Office or the U.S. Government.

1 Introduction

Cellular radio signal processing functions include modulation/demodulation, channel coding/decoding, equalization and diversity combining. These functions are performed by the radio modem. Current cellular radio modems do not, however, efficiently exploit the spatial dimension offered by multiple antennas. The spatial domain can be used to reduce co-channel interference (CCI), increase diversity gain, improve array gain, and reduce intersymbol interference (ISI). These improvements can have significant impact on the overall performance of a wireless network. Modems that operate with multiple antennas in receive and in transmit can exploit the spatial domain by performing *space-time processing* (STP). Receive STP improves signal to interference ratio through CCI cancellation, mitigates fading through improved receive diversity, offers higher signal to noise ratio through array gain and reduces ISI through spatial equalization. Likewise, transmit STP reduces CCI generation, improves transmit diversity and in some cases also minimizes ISI generation.

In this paper, we present a taxonomy of space-time processing. One classification of STP techniques is based on architecture, and covers different design choices for the physical layer of the wireless network. Another classification of STP techniques is based on algorithms and refers to choices of signal processing algorithms and optimization criterias. Underlying and affecting both these classifications are the characteristics of the physical channel that include angle, delay and Doppler spreads, see Figure 1.

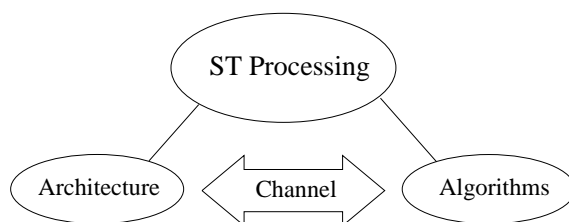

Figure 1: STP: Architecture, Algorithms and the Channel

The paper is organized as follows. Section 2 presents an architecture oriented classification, while section 3 presents an algorithm oriented classification. Section 4

discusses the influence of the channel on the choice of architecture and algorithms. Section 5 illustrates the taxonomy through two examples. Finally section 6 gives a summary of the paper.

2 Architecture

Architecture oriented classification is based on different choices of the physical layer design of the wireless system that is directly affected by STP. We can view architectural classification along the three directions shown in Figure 2. First, in *Link Structure* we make choices about where and how STP is to be applied to the network elements. Next, in *Channel Reuse* we make choices for reusing the frequency spectrum. Finally *Multiple Access* scheme is an important aspect of the physical layer that affects STP.

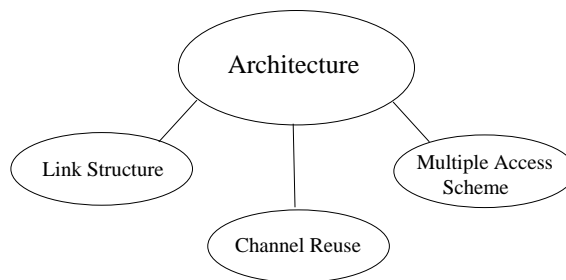

Figure 2: Architecture classification

2.1 Link Structure

Link structure refers to all aspects of STP related to the radio links between the base station and the subscriber. The link structure, in turn, can be classified based on the number of antennas at the base and the subscriber unit, and the use of STP on receive and transmit. We discuss these issues below.

2.1.1 STP at the Base station and Subscriber unit

STP using multiple antennas can be applied at the base station, the subscriber unit or at both locations. A number factors influencing these choices are discussed

here. The differences in propagation environment, physical limitations and cost constraints result in different choices of type and number of antennas at the base and the subscriber unit. Base stations can employ multiple antenna elements more easily because size and cost constraints are less restrictive. Antennas are an important source of diversity when the correlation between the antenna elements is not too high. At the subscriber unit, the presence of local scatterers provides adequate decorrelation with a spacing of 0.3 to 0.5 wavelengths spacing between the antennas. At the base stations, a spacing of 5 to 10 wavelengths may be needed to obtain similar decorrelation [1]. For these reasons, the number of antennas, element design, spacing and topology have different drivers at the base and the subscriber unit. STP at the base is the primary focus today although STP at the subscriber unit is an emerging technology. One example of the latter is the use of dual antennas in the handset in the North American PACS standard.

2.1.2 Receive and Transmit STP

STP can be used in receive alone, in transmit alone or on both links. The factors that influence these choices are discussed here. The key difference in the two links is the difficulty in determining the transmit channel needed for transmit STP.

STP performance in receive and transmit can be very different due to the differences in the knowledge of the associated channels. In receive, the channel can be estimated (by non-blind or blind methods) since the signal has traveled through the channel before being observed at the receiver. Also, interference is present at the receiver input and therefore can be characterized and canceled. On the other hand, in transmit, the channel is encountered after the signal leaves the antenna array and therefore, use of STP in transmit requires prior knowledge of the channel. Moreover, interference reduction in transmit requires knowledge of the channels to the co-channel subscribers. Again, these are difficult to estimate. Both these factors makes transmit STP challenging. See [2].

Figure 3 shows different link structures depending on the number of antennas used in receive and in transmit. These options can be associated with the downlink (base to subscriber) or the uplink (subscriber to base). Depending on the number of

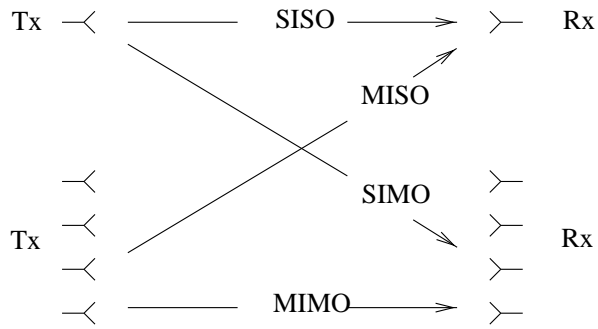

Figure 3: Link Structure

antennas, we can classify the channel as Single Input (**SI**) or Multiple Input (**MI**) for transmit and Single Output (**SO**) or Multiple Output (**MO**) for receive.

2.2 Channel Reuse

2.2.1 Channel Reuse Between Cells

Current TDMA systems employ channel reuse between cells (RBC). We expect to see only one desired signal at the base station or the subscriber unit, and interfering co-channel signals from other cells.

TDMA systems typically have a reuse factor¹, K , ranging from three to twelve. Smaller reuse factors thus offer higher spectral efficiency. The lower limit of the reuse factor depends on the tolerance to co-channel interference. Further one can use sectorization wherein a cell is divided into a number of equal sectors and the frequencies within the cell are divided among the sectors. The sectors in a cluster then all use different frequencies. Sectorization further reduces the effect of CCI. It is typical to describe a cellular layout as K/L where K refer to the number of cells per cluster L refer to the number of sectors per cluster.

CDMA systems generally have a reuse factor of one, i.e. the whole spectrum is reused in every cell. The cells can also here be divided into sectors where each sector in general will reuse the whole spectrum.

STP can be used in both the uplink and the downlink to reduce CCI. This can

¹This refers to the number of cells in a cluster. Cells within a cluster do not use the same frequency. The reuse factor therefore determines how close a co-channel cell can be located.

allow a decreased reuse factor in TDMA. In the uplink, the base station can use STP in order to suppress close co-channel interferers. In the downlink, the base station can have directive transmission in order to minimize interference to other co-channel users. STP can also be employed at the subscriber unit to reduce CCI on both links.

2.2.2 Channel Reuse Within Cells

Considering TDMA, it may be possible with STP to support two or more links on the same channel within a cell. This will strongly effect the required STP. We can approach channel reuse from two view points, reuse at the base station and reuse at the subscriber unit, see Figure 4. These are discussed below.

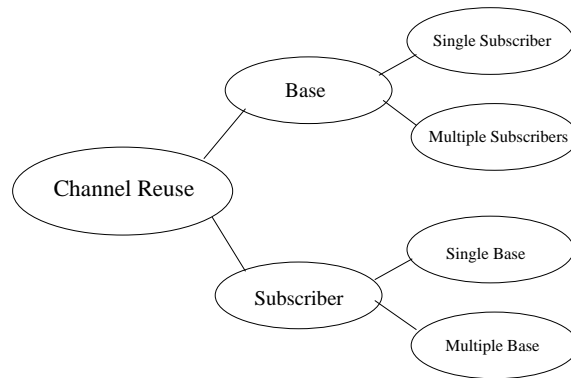

Figure 4: Channel reuse classification

Base Centered: Single vs Multi Subscriber Operation

The case when only one subscriber per channel is supported within a cell is here referred to as the Single Subscriber case (SS). On the other hand, as mentioned above, it is possible to support Reuse Within Cell (RWC) wherein we support multiple subscribers within the same cell (or sector) on the same channel. We call this the Multiple Subscriber case (MS). When supporting multiple subscribers per cell and channel in TDMA the signals typically have to be separated using STP. See for example [3][4][5] and [6].

CDMA systems support multiple subscribers on the same frequency channel.

The subscribers however use different spreading codes and can therefore be separated with time processing alone. However, STP can improve the performance.

The uplink and downlink in a communication system can have different channel reuse factors. We can, for instance, support aggressive reuse in the uplink, since receive STP is easier to implement, and use less aggressive reuse in the downlink where channel estimation problems may limit CCI cancellation. In order to balance the total number of subscribers in both links, asymmetric bandwidth assignment on the two links is required.

Subscriber Centered: Single Base vs Multi Base Operation

Subscriber units normally receives the downlink signals from one base station. However, for subscriber units with multiple antennas it is possible to receive multiple co-channel signals, carrying different information signals, from different base stations. Typically a high data rate signal would be split into multiple smaller data rate signals which are then transmitted simultaneously from different base stations on the same frequency channel. STP can be used to separate the co-channel signals and then combine these after demodulation resulting in higher spectral efficiency [7].

Similarly, when transmitting, the subscriber unit can split a high data rate signal into multiple lower data rate signals and transmit them with different spatial signatures. The signals will then be received by the base stations and separated using STP.

2.3 Multiple Access

The choice of multiple access (MA) plays a major role in the design of STP methods due to its effect on the characteristics of CCI. In TDMA, since the signal is not spread, one or two strong sources of CCI may be present in the RBC configuration [8]. STP can be used to null these few, but strong, interferers, see for example [9] and [10]. In CDMA, all users share the same channel and are separated by different spreading codes, allowing time domain processing to reduce CCI. Therefore, in CDMA, the STP has to deal with a large number of weak interferers. This difference affects the strategies for CCI suppression.

We can combine link, channel reuse and multiple access approaches to yield a variety of different architectures that employ STP. Example configurations where multiple antennas are used at the base station together with RBC reuse in a TDMA system are shown in Figure 5.

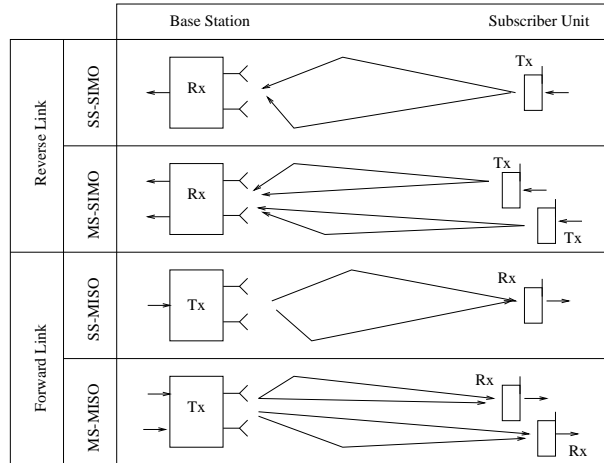

Figure 5: Example TDMA configurations.

3 Algorithms

Algorithms for STP can be divided into those used for channel estimation and those used for receive and transmit processing, see Figure 6. We briefly discuss algorithms in these groups below. The receive algorithms for TDMA and CDMA are treated separately.

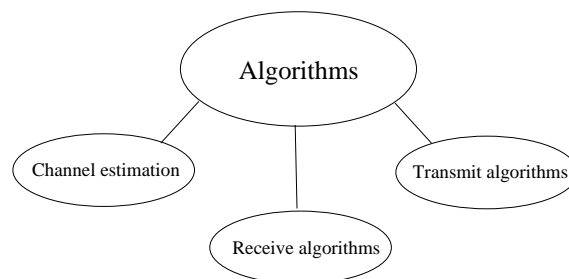

Figure 6: Algorithm classification.

3.1 Channel Estimation Algorithms

ST channel estimation algorithms can be divided into the receive and the transmit case. In receive channel estimation algorithms we can use non-blind or blind methods. In blind methods, no training signals are available and the underlying structure of the channel and/or the signal modulation format can be used to estimate the channel. Blind methods for channel estimation have been an active area of research. See [11] for a review of these methods. In non-blind methods, training signals are transmitted along with the information signal so as to enable channel estimation by the receiver. Again, a number of non-blind techniques use a burst of training symbols, pilot tones, pilot symbols or pilot codes. See [12] for more details.

In estimation of the transmit channel, we have two broad approaches - reciprocity and feedback. In the reciprocity method, we use that fact that the transmit and receive channels at the same frequency and at the same time are identical according to principle of reciprocity. Since the receive channel can be estimated as described earlier, the transmit channel can therefore sometimes be approximated using this principle. In frequency division duplexed (FDD) systems, the transmit and receive frequencies are separated by 4 to 5% of the carrier frequency. However, if the angular spread of the signal is small, the spatial signature of the channel will be approximately reciprocal [13]. In time division duplexed (TDD) systems, receive and transmit are separated in time. The reciprocity will then only be valid if the duplexing time is much shorter than the coherence time. The accuracy of the transmit channel estimation thus depends upon the duplexing technique and the channel characteristics. Another approach for transmit channel estimation uses feedback. The signal received at the receiver is fed back to the transmitter, allowing the transmitter to estimate the channel, see for example [14]. Alternatively, the transmit channel identified at the receiver can be fed back to the transmitter. Once again, the performance of the feedback techniques depends on the channel characteristics and the nature of the feedback algorithm. Transmit ST channel estimation offers special challenges and remains an active area of research. See [11] for more details.

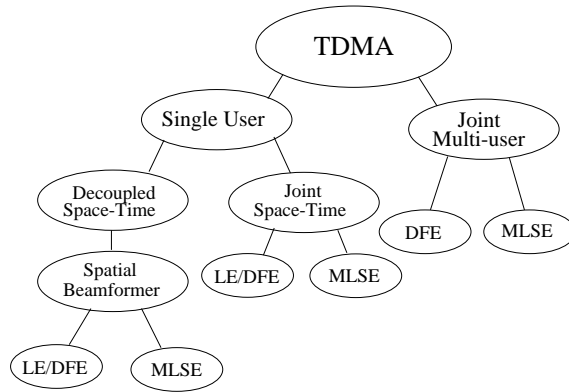

Figure 7: TDMA algorithm classification

3.2 TDMA Receive Algorithms

In TDMA the main tasks to be performed are diversity reception, ISI equalization and CCI suppression. We can classify TDMA algorithms into STP that is decoupled or joint in the spatial and temporal domains. Figure 7 illustrates this.

3.2.1 Single User Decoupled Space-Time Approach

In STP, we can decouple the space and time processing. This will lead to a spatial beamformer front end followed by a temporal processor (equalizer). The pure spatial processor can be used to reduce co-channel interference while maximizing spatial diversity. The output of the spatial processor is fed to a temporal processor for ISI reduction and recovery of temporal diversity. The spatial processor can range from a fully adaptive beamformer to a simpler switched beam system. The main options for the temporal processor are a linear equalizer (LE), a decision feedback equalizer (DFE), or a maximum likelihood sequence estimator (MLSE).

3.2.2 Single User Joint Space-Time Approach

In the presence of coupled angle and delay spreads for the desired signal, a joint STP approach has performance advantages. Joint STP is also better at dealing with delay spread in the CCI than decoupled space-time methods. A number of receiver structures have been proposed, broadly divided into ST linear equalizers, decision feedback equalizers, and ST maximum likelihood sequence estimators. See

for example [11][15][16][9][10][17] and [18].

3.2.3 Multi-User Detection

With multiple antennas, joint multi-user detection in TDMA becomes more robust than with one antenna. The spatial dimension helps to separate multi-user signals. The two main choices are a multi-user decision feedback equalizer [5] or a multi-user maximum likelihood sequence estimator. The multi-user decision feedback equalizer has a computational advantage over the MLSE since its complexity grows linearly with the number of users, whereas it increases exponentially in the number of users for the MLSE. A ST multi-user DFE is discussed in [5].

3.3 CDMA Receive Algorithms

We here restrict the discussion to DS-CDMA. In DS-CDMA the main tasks of the receiver are MA interference suppression and detection. A tree diagram of algorithm choices is shown in Figure 8.

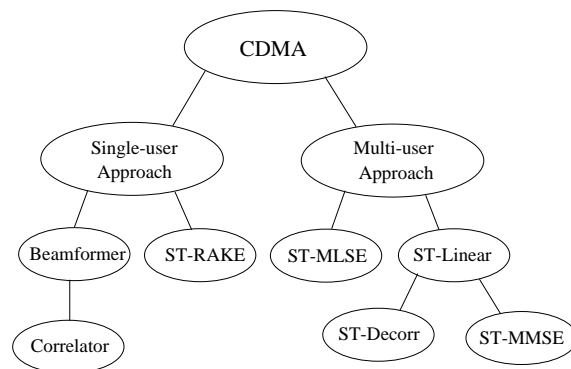

Figure 8: CDMA algorithm classification

There are two main classes of detection schemes for CDMA: the single-user detection approach and the multi-user detection approach. In the single-user approach, only one users signal at a time is recognized and the other signals are treated as noise. In the multi-user detection approach, all users are detected jointly.

3.3.1 Single-user Detection

The ST-processing can here be decoupled into a spatial beamformer followed by a simple correlating detector using the spreading code. This is the space-time counterpart of the simple correlating receiver. It exploits a single received path (finger) and is useful in environments with no multipath propagation. See for example [19].

If several paths (fingers) are present, the filtering can be done jointly in time and space. The natural choice would be the ST-RAKE receiver which is a combination of one beamformer per path followed by a RAKE combiner. It can also be viewed as a ST-matched filter. See for example [20].

3.3.2 Multi-user Detection

Although one can conceive decoupled space and time multi-user detection schemes, we will here only consider joint space-time multi-user detection schemes. The multi-user detection approaches can be divided into the MLSE detector and linear detectors. The space-time multi-user MLSE generalizes from the time-only multi-user MLSE. See [21] and [22]. The MLSE will be optimal if the channels for all users are known. However, as in TDMA, it is computationally complex.

The linear detectors are much less computationally complex. Examples of linear detectors are the ST decorrelating detector and the ST-MMSE detector, see [22] and [23].

3.4 Transmit Algorithms

ST Transmit algorithms use a variety of techniques to maximize diversity, minimize generated CCI and also in some situations pre-equalize the channel for ISI [11][2]. In general since ISI equalization can be implemented at the receiver, transmit STP focuses on diversity gain maximization and CCI reduction. In cases when the transmit channels for the signal and co-channel users are known, the transmit algorithms can implement optimum ST weighting to maximize diversity gain while minimizing generated CCI. Here again, both decoupled and joint space-time approaches can be considered, with the latter offering improved performance. In the more likely scenario when the co-channel users channels are unknown and the signal channel is

known only approximately, transmit algorithms may use simple beamforming with the beam steered towards the dominant mobiles direction with low side lobes to reduce CCI generation. In the extreme case when no channel knowledge is available, the transmit algorithms reduces to pure diversity maximization schemes. These schemes convert the space diversity of the transmit antennas into other forms of diversity that can be exploited by the receiver. Some examples include phase rolling, delay diversity and space-time coding [26][27][28].

4 Influence of the Channel on STP

STP algorithms are also profoundly influenced by channel characteristics. In STP, the channel is broadly defined to include the interference channel. A description of the effect of channel characteristics and corresponding mitigation techniques are given in Figure 9. A presentation of Doppler and delay spread of mobile radio channels can be found in [1].

	Effect	Mitigation
Doppler Spread	<ul style="list-style-type: none"> - Time varying channel - Reduces reciprocity in TDD - Time selective fading 	<ul style="list-style-type: none"> - Channel tracking - Reduce TDD turn around time - Time diversity
Delay Spread	<ul style="list-style-type: none"> - ISI - Reduces reciprocity in time channel - Frequency selective fading 	<ul style="list-style-type: none"> - Equalization/RAKE - Angle selectivity - Frequency diversity
Angle Spread	<ul style="list-style-type: none"> - Space selective fading - Reduces reciprocity in space channel 	<ul style="list-style-type: none"> - Space diversity - Reduce frequency spread in FDD

Figure 9: Channel characteristics influencing STP

4.1 Doppler Spread

Doppler spread induced by subscriber or scatterer motion has a strong influence on STP algorithms in different dimensions. Doppler spread is large in macrocells which serve high mobility subscribers. Also it increases with higher operating frequencies. Doppler spread is also present in low mobility (microcell) or fixed wireless networks

due to mobility of scatterers (traffic).

Doppler spread has several effects on STP algorithms. In digitally modulated systems, if the *symbol* period is comparable to the coherence time (inversely proportional to the Doppler spread), we have a fast Doppler channel that causes BER flooring. Wireless systems are usually designed to avoid this condition.

In a TDMA system, if the *slot* period is small compared to the coherence time of the channel (as in GSM), the channel will be reasonably constant during the slot, and we do not need to track the channel during the slot. On the other hand if the slot duration is comparable to or longer than the coherence time of the channel (as in IS-136), the channel changes significantly and we need to track the channel during the slot.

Fading can sometimes be combatted in the time domain by interleaving and coding. This is however only effective if the coherence time is shorter than the interleaver depth. For slowly time varying channels, other forms of diversity may be necessary to ensure acceptable link quality.

Also, as mentioned in Section 3.1, in time division duplex systems, the reciprocity of the channel is valid only if the channel coherence time is much larger than the duplexing time.

4.2 Delay Spread

Delay spread arises from multipath and can be large in macrocell systems with antennas located above the roof top. It is largest in hilly terrain areas and least in flat rural terrain applications. Microcells using below roof top antennas tend to have small delay spreads.

Delay spread affects STP algorithms in several ways. In TDMA systems, if the symbol period is much shorter than the delay spread of the channel, we can avoid equalizers (as in PACS and PHP). In contrast, in GSM, the delay spread can be much larger than the symbol period mandating the use of equalizers. Channel equalization for delay spread, can be handled by STP in both space and time. In general, combined space and time processing is more effective for delay spread mitigation than time processing alone.

Likewise, in CDMA, if the delay spread is larger than the chip period, we have inter-chip interference which, however, is usually much less insidious than the ISI in TDMA. Typically, the diversity in paths is exploited by a RAKE receiver.

4.3 Angle Spread

Angle spread arises from multipath arrivals from different directions. It is largest at the subscriber unit, where local scatterers may result in 360 degrees angle spread. At the base station, the angle spread is large in microcells with below roof top antennas. Base stations in macrocells witness less angle spread, it is the lowest in rural regions and becomes significant in urban and hilly regions.

Angle spread influences a number of STP issues. First, high angle spread increases spatial diversity which should be exploited by STP. Next, as mentioned in Section 3.1, the reciprocity of the spatial signature of the channel reduces if the angle spread is large.

5 Two Examples

We apply the above described taxonomy to two well known air interfaces which are assumed to have been enhanced with STP techniques.

5.1 GSM

Assume a GSM air interface with receive and transmit antenna array processing at the BS. The subscriber units use a single antenna. Also only a single subscriber is allowed within a cell in a given channel. We assume the base station antennas are above rooftop. Let the channel be a typically urban channel with 60 MPH mobile speed and a carrier frequency of 1800Mhz. We further assume a training sequence is available for tuning of the processing algorithms. The overall classification of this STP problem will then be:

- Architecture

- Link Structure
 - * Base: STP in Rx and Tx
 - * Subscriber: Time processing only
 - * Uplink channel: SIMO
 - * Downlink channel: MISO
- Channel Reuse
 - * At Base : Single subscriber
 - * At Subscriber: Single base
- Multiple Access: TDMA
- Algorithms
 - Joint ST MLSE
- Channel
 - Delay spread: High
 - Doppler spread: Low
 - Angle Spread (Base): Low to Medium
 - Angle Spread (Subscriber): High

5.2 DECT

Assume a DECT air interface with an antenna array at the BS. The subscriber units use a single antenna. Also multiple subscribers are allowed within a cell. We assume small cells (microcells) with rooftop or below rooftop antennas. The subscriber units are slow moving. Because of the small cells, the delay spread will be very small and the equalizer will mainly deal with the ISI from the GMSK modulation. For this reason we can employ decoupled STP with a beamformer followed by a temporal equalizer. The overall classification of this STP problem will be:

- Architecture
 - Link Structure

- * Base: STP in Rx and Tx
- * Subscriber: Time processing only
- * Uplink channel: SIMO
- * Downlink channel: MISO
- Channel Reuse
 - * At Base : Multiple subscribers
 - * At Subscriber: Single base
- Multiple Access: TDMA
- Algorithms
 - Decoupled Space and time. Spatial beamformer followed by a temporal DFE or MLSE.
- Channel
 - Delay spread: Negligible
 - Doppler spread: Low
 - Angle Spread (Base): Medium to high
 - Angle Spread (Subscriber): High

6 Summary

Use of space-time processing is emerging as a powerful tool for improving performance of cellular wireless networks. In this paper we provide a taxonomy for STP algorithms from a variety of viewpoints. The complex nature of STP makes it impossible to classify all of its dimensions in a precise manner. We present one approach here. We hope it will help to better define and differentiate STP algorithms and will provide insightful background for future research.

7 References

- [1] W.C. Lee, *Mobile Cellular Telecommunications*. New York: McGraw-Hill, 1995.
- [2] Derek Gerlach. *Adaptive Transmitting Antenna Arrays at the Base Station in Mobile Radio Networks*, PhD thesis, Stanford University, Dept. of Electrical Engineering, Stanford, CA, USA, 1995.
- [3] J. Winters, "On the capacity of radio communication systems with diversity in a Rayleigh fading environment," *IEEE J. Select. Areas Commun.*, vol. 5, no. 5, pp. 871–878, June 87.
- [4] D.D. Falconer, M. Abdulrahman, N.W.K. Lo, B.R. Petersen and A.U.H. Sheik, "Advances in equalization and diversity for portable wireless systems," *Digital Signal Processing*, vol. 3, pp. 148–62, 1993.
- [5] Claes Tidestav, "Narrowband and broadband multiuser detection using a multivariable DFE," in *Proceedings of PIMRC'95*, Toronto, Canada, September 27-29 1995, pp. 732–736.
- [6] S. Talwar, M. Viberg, and A. Paulraj, "Blind separation of synchronous co-channel digital signals using an antenna array. Part I. Algorithms," *IEEE Transactions on Signal Processing*, vol. 44, no. 5, pp. 1184–1197, May 1996.
- [7] A. Paulraj and T Kailath, "Increasing capacity in wireless broadcast systems using distributed transmission and directional reception," US Patent 5,345,599.
- [8] Bo Hagerman, "Downlink relative co-channel interference powers in cellular radio systems," in *Proceedings of VTC'95*, vol. 2, Rosemont, IL, USA, 1995, pp. 366–370.
- [9] E. Lindskog, A. Ahlén, and M. Sternad, "Spatio-temporal equalization for multipath environments in mobile radio applications," in *Proceedings of the 45th IEEE Vehicular Technology Conference*, Rosemont, Illinois, USA, July 26-69 1995, pp. 399–403.
- [10] E. Lindskog, "Multi-channel maximum likelihood sequence estimation," in *Proceedings of the 47th IEEE Vehicular Technology Conference*, vol. 2, Phoenix, Arizona, USA, May 5-7 1997, pp. 715–719.
- [11] A.J. Paulraj and C.B. Papadias, "Space-time processing for wireless communications," *Signal processing magazine*, November 1997.
- [12] S. Sampei, *Applications of Digital Wireless Technologies to Global Wireless Communications*: Prentice Hall, 1997.
- [13] G. Raleigh, S. Diggavi, V. Jones, and A. Paulraj, "A blind adaptive transmit antenna algorithm for wireless communication," in *Proc. ICC*, 1995.
- [14] Derek Gerlach, "Transmit antenna beamforming for the advanced mobile phone system," in *Proceedings of 29th Asilomar Conference on Signals, Systems & Computers*, Pacific Grove, California, U.S.A., October 30 - November 1 1995.
- [15] Jack H. Winters, "Signal acquisition and tracking with adaptive arrays in wireless systems," in *Proc. 43rd Vehicular Technology Conf.*, vol. I, November 1993.
- [16] P. Balaban and J. Salz, "Optimum diversity combining and equalization in digital data transmission with applications to cellular mobile radio," *IEEE Transactions on Communications*, vol. 40, no. 5, pp. 885–907, May 1992.

- [17] P. Vila, F. Pipon, D. Pirez, and L. Féty, "MLSE antenna diversity equalization of a jammed frequency-selective fading channel," in *Proceedings of EUSIPCO'94*, Edinburg, UK, 1994, pp. 1516–1519.
- [18] J.W. Modestino and V.M. Eyuboglu, "Integrated multielement receiver structures for spatially distributed interference channels," *IEEE Transactions on Information Theory*, vol. 32, no. 2, pp. 195–219, March 1986.
- [19] B. Suard, A. Naguib, G. Xu, and A. Paulraj, "Performance analysis of CDMA mobile communication systems using antenna arrays," in *Proc. ICASSP'93*, vol. VI, Minneapolis, MN, April 1993, pp. 153–156.
- [20] A. F. Naguib and A. Paulraj, "Performance of wireless CDMA with M-ary orthogonal modulation and cell site antenna arrays," *Journal on Selected Areas in Communication*, vol. 14, no. 9, pp. 1770–1783, December 1996.
- [21] S. Verdu, "Minimum probability of error for asynchronous Gaussian multiple-access channels," *IEEE Trans. Inform. Theory*, vol. 32(1), pp. 85–96, January 1986.
- [22] S. Miller and S. Schwartz, "Integrated spatial-temporal detectors for asynchronous Gaussian multiple access channels," *IEEE Transactions on Communications*, vol. 43, no. 2/3/4, pp. 396–411, February/March/April 95.
- [23] M. Nagatsuka and R. Kohno, "A spatially and temporally optimal multi-user receiver using an array antenna for DS/CDMA," *IEICE Transactions on communications*, vol. E78-B, no. 11, pp. 1489–1497, November 1995.
- [24] R. Lupas and S. Verdú, "Linear multiuser detectors for synchronous code-division multiple-access channels," *IEEE Transactions on Information Theory*, vol. 35, no. 1, pp. 123–136, Jan. 1989.
- [25] U. Madhow and M. Honig, "MMSE interference suppression for direct-sequence spread-spectrum CDMA," *IEEE Trans. Communications*, vol. 42, no. 12, pp. 3178–3188, December 1994.
- [26] V. Torakh, N. Seshadri, and A. R. Calderbank, "Space-time codes for high data rate wireless communication: performance criterion and code construction," Submitted to *IEEE Trans. on Information Theory*.
- [27] V. Torakh, A. Naguib, N. Seshadri, and A. R. Calderbank, "Space-time coding for high data rate wireless communication: Practical considerations," Submitted to *IEEE Trans. on Communications*.
- [28] V. Torakh, A. Nabguib, N. Seshadri, and A. R. Calderbank, "Space-time coding for high data rate wireless communication: combined array processing and space-time coding," Preprint.
- [29] Bjorn Ottersten, "Array processing for wireless communications," in *8th IEEE Signal Processing Workshop on Statistical Signal and Array Processing*, Corfu, June 24-26 1996, pp. 466–473.
- [30] Y-S Yeh and D. O. Reudink, "Efficient spectrum utilization for mobile radio systems using space diversity," *IEEE Trans. Communications*, vol. COM-30, no. 3, pp. 447–455, March 1982.
- [31] J. Ward and R. T. Compton, Jr., "High throughput slotted ALOHA packet radio networks with adaptive arrays," *IEEE Transactions on Communications*, vol. 41, no. 3, pp. 460–470, March 1993.

- [32] S. C. Swales, M. Beach, D. Edwards, and J. P. McGeehan, "The performance enhancement of multibeam adaptive base-station antennas for cellular land mobile radio systems," *IEEE Transactions on Vehicular Technology*, vol. 39, no. 1, pp. 56–67, Feb. 1990.
- [33] L. Acar and R. T. Compton, "The performance of LMS adaptive array with frequency hopped signals," *IEEE Trans. Aerospace Electron. Syst.*, vol. AES-21, pp. 360–370, May 1985.
- [34] J. Li, B. Halder, P. Stoica, and M. Viberg, "Computationally efficient angle estimation for signals with known waveforms," *IEEE Transactions on Signal Processing*, vol. 43, pp. 2154–2164, 1995.
- [35] B. D. Van Veen and K. M. Buckley, "Beamforming: a versatile approach to spatial filtering," *IEEE Acoustics, Speech and Signal Processing Magazine*, pp. 4–24, April 1988.
- [36] S. Anderson, "An adaptive array for mobile communications systems," *IEEE Trans. Veh. Technology*, vol. 40, February 1991.
- [37] M. Viberg and B. Ottersten, "Sensor array processing based on subspace fitting," *IEEE Transactions on Signal Processing*, vol. 39, no. 5, pp. 1110–1121, May 1991.
- [38] M. Viberg, B. Ottersten, and T. Kailath, "Detection and estimation in sensor arrays using weighted subspace fitting," *IEEE Transactions on Signal Processing*, vol. 39, no. 11, pp. 2436–2449, Nov. 1991.
- [39] M. Wax and I. Ziskind, "On unique localization of multiple sources by passive sensor arrays," *IEEE Transactions on Acoustics, Speech, and Signal Processing*, vol. 37, pp. 996–1000, July 1989.
- [40] G. Xu and H. Liu, "An effective transmission beamforming scheme for frequency-division-duplex digital wireless communication systems," in *Proc. ICASSP-95*, Detroit, MI, 1995, pp. 1729–1732.
- [41] M. D. Zoltowski and J. Ramos, "Blind adaptive beamforming for CDMA Based PCS/Cellular," in *Proc. 29th Asilomar Conference on Signals, Systems and Computers*, Pacific Grove, CA, Oct. 31 - Nov. 2 1995.
- [42] T. Trump and B. Ottersten, "Estimation of nominal direction of arrival and angular spread using an array of sensors," *Signal Processing*, vol. 50, pp. 57–69, 1996.
- [43] P. Zetterberg and B. Ottersten, "The spectrum efficiency of a base station antenna array system for spatially selective transmission," *IEEE Trans. on Vehicular Technology*, vol. 44, no. 3, pp. 651–660, August 1995.
- [44] M. Cedervall and R. Moses, "Decoupled maximum likelihood angle estimation for coherent signals," in *29th Asilomar Conference on Signals, Systems and Computers*, Pacific Grove, CA, U.S.A., Oct 30 - Nov 1 1995.
- [45] E. Lindskog, "Array channel identification using directional of arrival parametrization," in *Proceedings of IEEE International Conference on Universal Personal Communications*, Cambridge, Massachusetts, U.S.A., September 29 - October 2 1996, pp. 999–1003.

List of Figures

1	STP: Architecture, Algorithms and the Channel	2
2	Architecture classification	3
3	Link Structure	5
4	Channel reuse classification	6
5	Example TDMA configurations.	8
6	Algorithm classification.	8
7	TDMA algorithm classification	10
8	CDMA algorithm classification	11
9	Channel characteristics influencing STP	13